





Rørsystem – prisliste 2025



Prislisten er gældende fra 1.1.2025
Priserne er nettopriser pr. stk., ekskl. moms, ab lager Greve
Dansk Procesventilation ApS tager forbehold for fejl, mangler og ændringer

Dustcontrol rørsystem

Stål varmgalvaniseret

Rør 3 m											
		Art.nr.	Dimension	Ø	l (m)			t	Kg /m	Pris pr. stk. DKK	
		3071	Ø50	50,8	3				1,5	1,82	480,-
		3004	Ø76	76	3				1,5	2,60	675,-
		3039	Ø108	108	3				2,0	3,90	1.350,-
		3060	Ø159	159	3				1,5	7,70	1.875,-

Rør 6 m (rørbundt)

Rør 6 m (rørbundt)											
		Art.nr.	Dimension	Ø	l (m)	Total /m		t	Kg /m	Pris pr. stk. DKK	
		3943	Ø76	76	37x6	222			1,5	2,60	48.355,-
		3944	Ø108	108	23x6	138			2,0	3,90	52.660,-

Bøjninger 90° almindelige

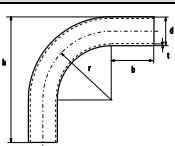
Bøjninger 90° almindelige										
		Art.nr.	Dimension	Ø	r	b	h	t	kg	Pris pr. stk. DKK
		3310	Ø50	50,8	120	75	220	1,5	0,60	150,-
		3311	Ø76	76	160	108	313	1,5	1,30	220,-
		3319	Ø108	108	160	165		2,0	3,00	825,-

Bøjninger 90° korte

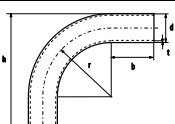
Bøjninger 90° korte										
		Art.nr.	Dimension	Ø	r	b	h	t	kg	Pris pr. stk. DKK
		3309	Ø50	50,8	85	75	185	1,5	0,30	145,-
		3117	Ø50	50,8	50	-	115	1,5	0,30	450,-
		3118	Ø76	76	65	-	150	1,5	0,60	430,-

Bøjninger 90° med stor bøjningsradius til materialetransport

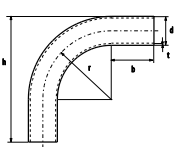
Bøjninger 90° med stor bøjningsradius til materialetransport										
		Art.nr.	Dimension	Ø	r	b	h	t	kg	Pris pr. stk. DKK
		3169	Ø76	76	175	150	-	2,9	3,0	2.140,-
		3165	Ø108	108	250	150	-	3,6	6,5	4.215,-
		3161	Ø159	159	375	150	-	4,5	15,3	5.445,-

Bøjninger 90° slidstærk

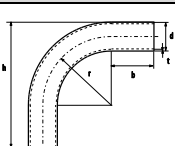
Bøjninger 90° slidstærk										
		Art.nr.	Dimension	Ø	r	b	h	t	kg	Pris pr. stk. DKK
		3235	Ø76	87	175	50	-	7,0	5,0	2.315,-
		3234	Ø108	121	250	50	-	5,5	10,6	3.160,-

Stål varmgalvaniseret - fortsat

Bøjninger 45°

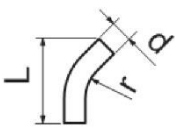
		Art.nr.	Dimension	Ø	r	l	h	t	kg	Pris pr. stk. DKK
		3312	Ø50	50,8	120	-	-	1,5		
3317	Ø76	76	160	333	-	1,5			185,-	
3321	Ø108	108	160	433	-	2,05			610,-	
3062	Ø159	159	375	166,5	-	4,5			1.285,-	

Y-rør

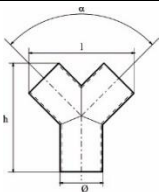
		Art.nr.	Dimension	Ø	a	l	h	t	kg	Pris pr. stk. DKK
		3324	Ø50	50,8	90°	150	175	1,5	0,50	
3323	Ø76	76	90°	190	195	1,5	0,70		810,-	
3322	Ø108	108	90°	235	225	2,0	1,40		1.320,-	

Grenrør

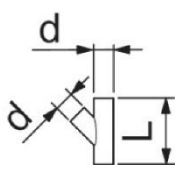
		Art.nr.	Dimension	Ø	a	l	h	t	kg	Pris pr. stk. DKK
		3074	Ø50/50	50,8/50,8	45°	170	-	1,5		
3003	Ø76/76	76/76	45°	245	-	1,5			430,-	
3357	Ø108/108	108/108	45°	267	-	1,5			735,-	
3036	Ø108/76	108/76	45°	300	-	1,5			615,-	
3065	Ø159/76	159/76	30°	390	-	2,0			1.325,-	
3064	Ø159/108	159/108	30°	390	-	2,2			1.820,-	
3063	Ø159/159	159/159	45°	400	-	2,0			1.580,-	

Reduktioner

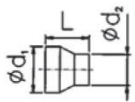
		Art.nr.	Dimension	Ød ₁	Ød ₂	l	h	t	kg	Pris pr. stk. DKK
		3078	Ø76/50	76	50,8					
3197	Ø80/76	80	76	70	-	2,0	0,20		975,-	
3030	Ø108/76	108	76	95	-	1,0	0,15		470,-	

For andre dimensioner henvises til gummirør tilbehør, reduktioner.

Endebunde

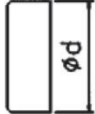
		Art.nr.	Dimension	Ø					kg	Pris pr. stk. DKK
		3172	Ø50	50,8						
3174	Ø76	76							180,-	
3906	Ø108	108							225,-	

Rørsamlinger EPDM

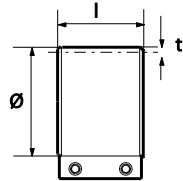
		Art.nr. EPDM	Dimension			d	l	t	kg	Pris pr. stk. DKK
		3077	Ø50				50,8	65	4,5	0,2
3007	Ø76				76	65	5,0	0,3	105,-	
3031	Ø108				108	65	5,5	0,4	115,-	
3045	Ø159				159	65	6,5	0,5	185,-	

Stål varmgalvaniseret - fortsat

Rørsamlinger NBR

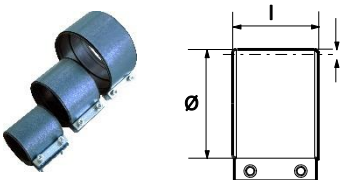
	Art.nr. NBR	Dimension			d	l	t	kg	Pris pr. stk. DKK
	3271	Ø50			50,8	65	4,5	0,2	135,-
	3272	Ø76			76	65	5,0	0,3	130,-
	3273	Ø108			108	65	5,5	0,4	150,-
	3274	Ø159			159	65	6,5	0,5	245,-

Rørsamlinger til slidstærk bøjning

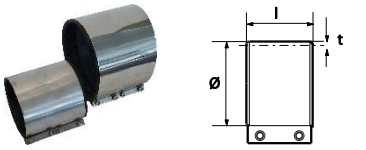
	Art.nr. EPDM	Dimension	Ød ₁	Ød ₂	l	t	kg	Pris pr. stk. DKK	
	3243	Ø76		87	76	130	-	0,5	1.000,-
	3244	Ø108		121	108	130	-	0,7	1.275,-

Syrefast rustfri Stål, syrefast rustfast EN1.4404. Poleret G320 og Ra 0,8 μ

Rør 4 m									
	Art.nr.	Dimension	Ø	l (m)			t	kg	Pris pr. stk. DKK
	44228	Ø50,0	50,8	4			1,0		1.120,-
	44227	Ø76,1	76	4			1,2		2.560,-
	44226	Ø108	108	4			1,5		3.520,-

Rustfri Stål, rustfast ss2333/Grade 1.4301/DIN X 5 CrNi 1810/UNSS30400/AFNOR Z 6 CN 18.09/ANSI 304/BS 304515

Rør 3 m									
	Art.nr.	Dimension	Ø	l (m)			t	kg	Pris pr. stk. DKK
	3227-1	Ø159	159	3			1,0	4,0	6.090,-

Bøjninger 90° almindelige

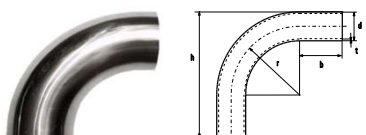
	Art.nr.	Dimension	Ø	r	b	h	t	kg	Pris pr. stk. DKK
	3314	Ø50	50,8	120	75	1,5	220	0,6	275,-
	3316	Ø76	76	160	180	1,5	313	1,3	590,-
	3320	Ø108	108	160	165	2,0	380	3,0	1.215,-
	3262	Ø159	159	87	90	1,0	260	1,8	5.620,-

Bøjninger 90° med stor arbejdsradius til materialetransport

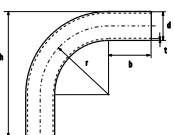
	Art.nr.	Dimension	Ø	r	b	h	t	kg	Pris pr. stk. DKK
	3266	Ø76	76	460	-	-	-	3,2	3.050,-
	3303	Ø108	108	800	150	-	2,0	10,0	5.175,-

Bøjninger 45° almindelige

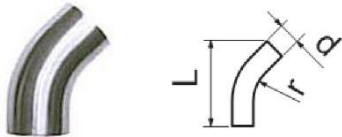
	Art.nr.	Dimension	Ø	r	l	h	t	kg	Pris pr. stk. DKK
	3313	Ø50	50	120	233	1,5	-		270,-
	3318	Ø76	76	160	333	1,5	-		450,-
	3315	Ø108	108	160	433	-	2,0		1.060,-

Y-rør

	Art.nr.	Dimension	Ø	a	l	h	t	kg	Pris pr. stk. DKK
	3331	Ø50	50,8	90°	150	175	1,5	0,4	2.430,-
	3330	Ø76	76	90°	190	195	1,5	0,7	2.635,-
	3329	Ø108	108	90°	235	225	2,0	1,4	3.080,-

Grenrør

	Art.nr.	Dimension	Ød ₁	Ød ₂	l	a	t	kg	Pris pr. stk. DKK
	3199	Ø76/76	76	76	245	45°	1,5		3.195,-
	3358	Ø108/108	108	108	267	45°	1,5		1.570,-

Rustfri Stål, rustfast ss2333/Grade 1.4301/DIN X 5 CrNi 1810/UNSS30400/AFNOR Z 6 CN 18.09/ANSI 304/BS 304515 – fortsat

Reduktioner

	Art.nr.	Dimension	Ød ₁	Ød ₂	l	h	t	kg	Pris pr. stk. DKK
	3078	Ø76/50	76	50,8					335,-
	3255	Ø108/76	108	76					2.650,-
	3258	Ø159/108	159	108					3.595,-

For andre dimensioner henvises til gummirør tilbehør, reduktioner.

Rørsamlinger rustfri

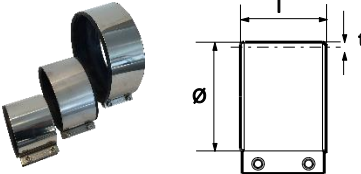
	Art.nr. EPDM	Dimension	d	l	t	kg	Pris pr. stk. DKK
	307702	Ø50	50,8	65	4,5	0,2	145,-
	300702	Ø76	76	65	5,0	0,3	145,-
	303102	Ø108	108	65	5,5	0,4	175,-
	304502	Ø159	159	65	6,5	0,5	220,-

Gummi fittings (stål) EPDM

45° bøjninger komplet med rørsamlinger

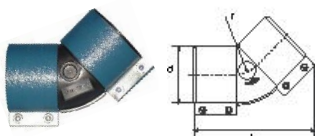
	Art.nr. EPDM	Dimension	d	l	r	kg	Pris pr. stk. DKK
	307311	Ø50	50,8	150	66	0,5	290,-
300911	Ø76	76	170	79	0,6	395,-	
302911	Ø108	108	195	94	0,8	460,-	

45° grenrør komplet med rørsamlinger

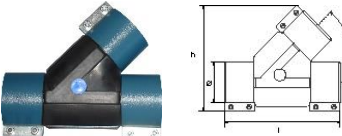
	Art.nr. EPDM	Dimension	d	l	h	kg	Pris pr. stk. DKK
	307411	Ø50	50,8	220	150	0,8	395,-
300311	Ø76	76	250	200	1,2	430,-	
303511	Ø108	108	300	260	1,6	560,-	

Reduktioner

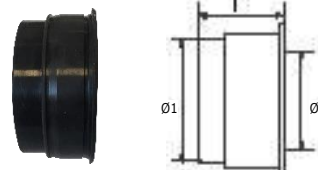
	Art.nr. EPDM	Dimension	d ₁	d ₂	l	kg	Pris pr. stk. DKK
	3305	Ø76/50	50,8	76	50	0,1	135,-
3306	Ø108/76	76	108	55	0,3	205,-	
3307	Ø108/100	100	108	35	0,1	195,-	
3308	Ø159/108	108	159	70	0,7	480,-	

Rørsamlinger

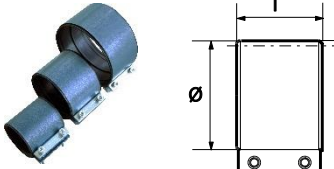
	Art.nr. EPDM	Dimension	d	l	t	kg	Pris pr. Stk. DKK
	3077	Ø50	50,8	65	4,5	0,2	115,-
3007	Ø76	76	65	5,0	0,3	105,-	
3031	Ø108	108	65	5,5	0,4	115,-	
3045	Ø159	159	65	6,5	0,5	185,-	

Tekniske Data

	EPDM	NBR
Temperatur °C max/min	140/-60	120/-60
Antistatisk	Ja	Ja
Slidstyrke	Meget god	God
Vejr- og ozonbestandighed	Meget god	Begrænset
Korrosionsbestandighed	Meget god	God
Bestandighed mod benzin og olie	Dårlig	Meget god

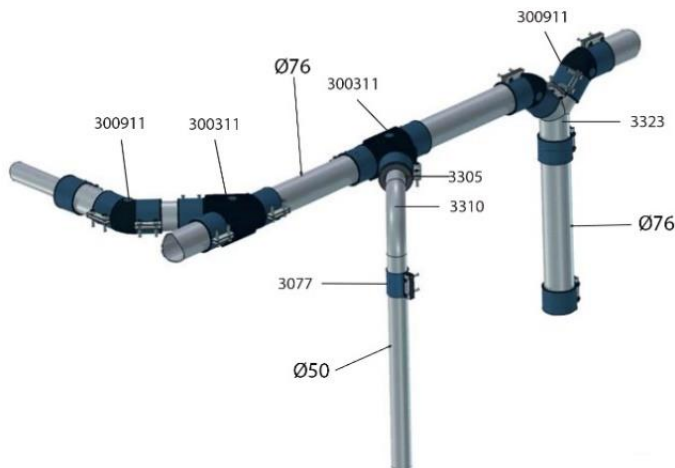

Gummi fittings (stål) NBR

45° bøjninger komplet med rørsamlinger

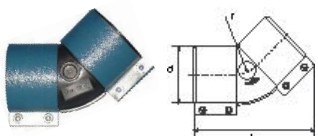
	Art.nr. NBR	Dimension	d	l	r	kg	Pris pr. stk. DKK
	307312	Ø50	50,8	150	66	0,5	310,-
300912	Ø76	76	170	79	0,6	380,-	
302912	Ø108	108	195	94	0,8	485,-	

45° grenrør komplet med rørsamlinger

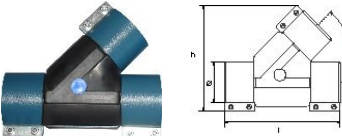
	Art.nr. NBR	Dimension	d	l	h	kg	Pris pr. stk. DKK
	307412	Ø50	50,8	220	150	0,8	395,-
300312	Ø76	76	250	200	1,2	430,-	
303512	Ø108	108	300	260	1,6	550,-	

Reduktioner

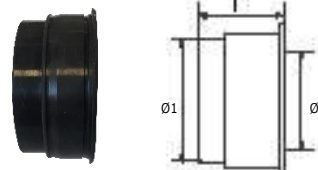
	Art.nr. NBR	Dimension	d ₁	d ₂	l	kg	Pris pr. stk. DKK
	3325	Ø76/50	50,8	76	50	0,1	150,-
3326	Ø108/76	76	108	55	0,3	195,-	
3327	Ø108/100	100	108	35	0,1	205,-	
3328	Ø159/108	108	159	70	0,7	460,-	

Rørsamlinger

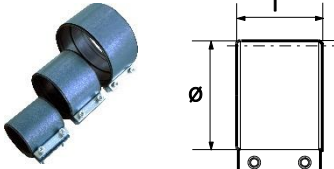
	Art.nr. NBR	Dimension	d	l	t	kg	Pris pr. Stk. DKK
	3271	Ø50	50,8	65	4,5	0,2	135,-
3272	Ø76	76	65	5,0	0,3	130,-	
3273	Ø108	108	65	5,5	0,4	150,-	
3274	Ø159	159	65	6,5	0,5	245,-	

Tekniske Data	EPDM	NBR
Temperatur °C max/min	140/-60	120/-60
Antistatisk	Ja	Ja
Slidstyrke	Meget god	God
Vejr- og ozonbestandighed	Meget god	Begrænset
Korrosionsbestandighed	Meget god	God
Bestandighed mod benzin og olie	Dårlig	Meget god

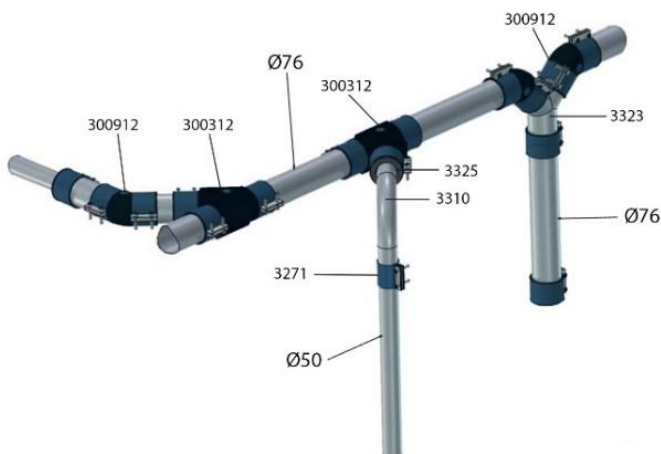

Gummi fittings (rustfri)

45° bøjninger komplet med rustfaste rørsamlinger

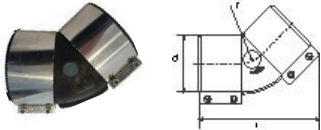
	Art.nr. EPDM	Dimension	d	l	r	kg	Pris pr. stk. DKK
	3343	Ø50	50,8	150	66	0,5	405,-
3344	Ø76	76	170	79	0,6	520,-	
3345	Ø108	108	195	94	0,8	625,-	

45° grenrør komplet med rustfaste rørsamlinger

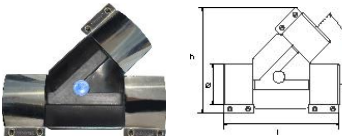
	Art.nr. EPDM	Dimension	d	l	h	kg	Pris pr. stk. DKK
	3346	Ø50	50,8	220	150	0,8	440,-
3347	Ø76	76	250	200	1,2	490,-	
3348	Ø108	108	300	260	1,6	615,-	

Reduktioner

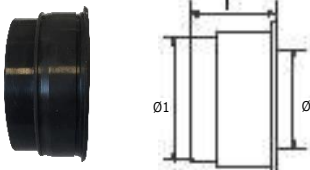
	Art.nr. EPDM	Dimension	d ₁	d ₂	l	kg	Pris pr. stk. DKK
	3305	Ø76/50	50,8	76	50	0,1	135,-
3306	Ø108/76	76	108	55	0,3	205,-	
3307	Ø108/100	100	108	35	0,1	195,-	
3308	Ø159/108	108	159	70	0,7	480,-	

Rørsamlinger rustfast

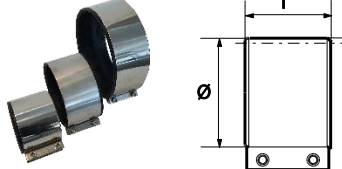
	Art.nr. EPDM	Dimension	d	l	t	kg	Pris pr. stk. DKK
	307702	Ø50	50,8	65	4,5	0,2	145,-
300702	Ø76	76	65	5,0	0,3	145,-	
303102	Ø108	108	65	5,5	0,4	175,-	
304502	Ø159	159	65	6,5	0,5	220,-	

Tekniske Data

	EPDM	NBR
Temperatur °C max/min	140/-60	120/-60
Antistatisk	Ja	Ja
Slidstyrke	Meget god	God
Vejr- og ozonbestandighed	Meget god	Begrænset
Korrosionsbestandighed	Meget god	God
Bestandighed mod benzin og olie	Dårlig	Meget god

